

MODULEC-SA: Emissa/Ruptura

Versions

EMISSA-(fail close)

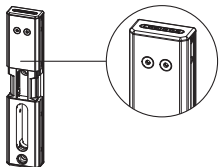

RUPTURA-(fail open)

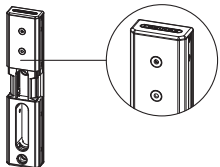

① Exploded view & dimensions

Package content

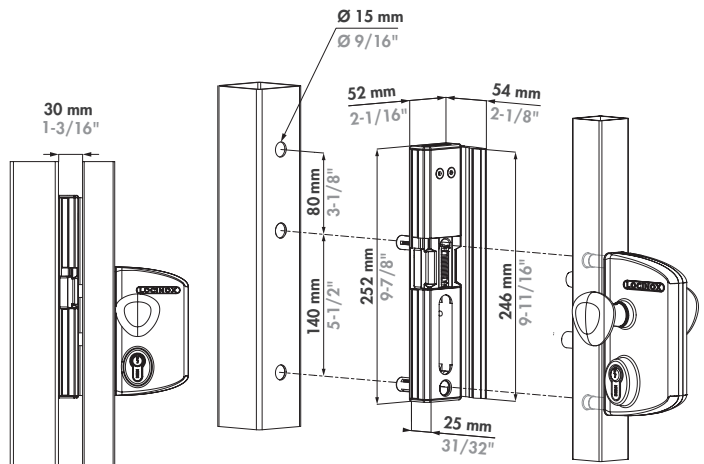
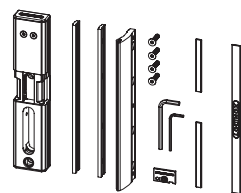

② Gate profile dimensions

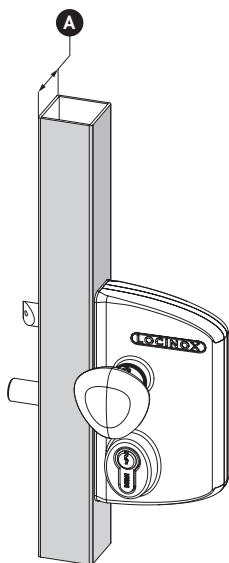

A = 40 mm
1- 5/8"

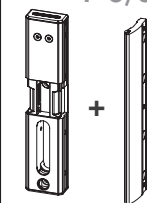

A = 50 mm
2"

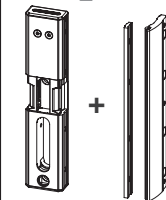

A = 60 mm
2- 3/8"

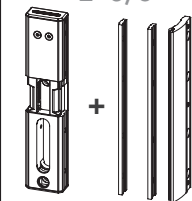

③ Left or right mounting

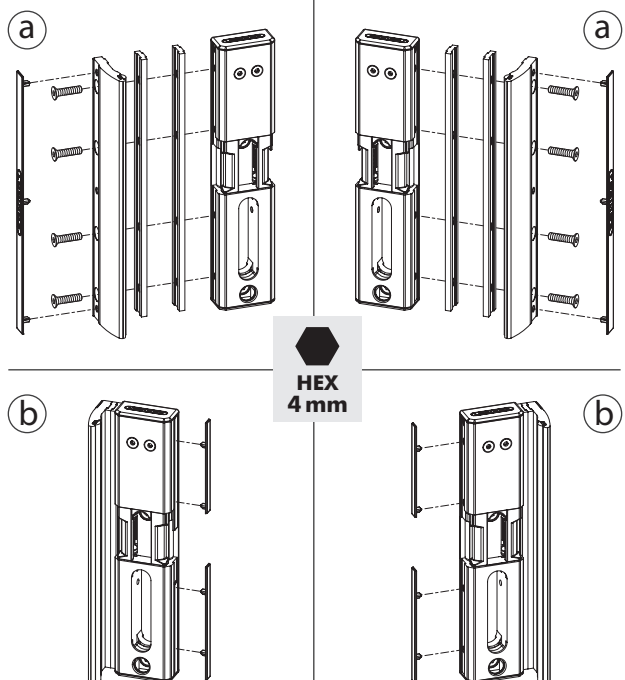
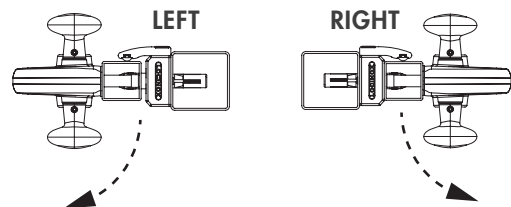

④ Mounting

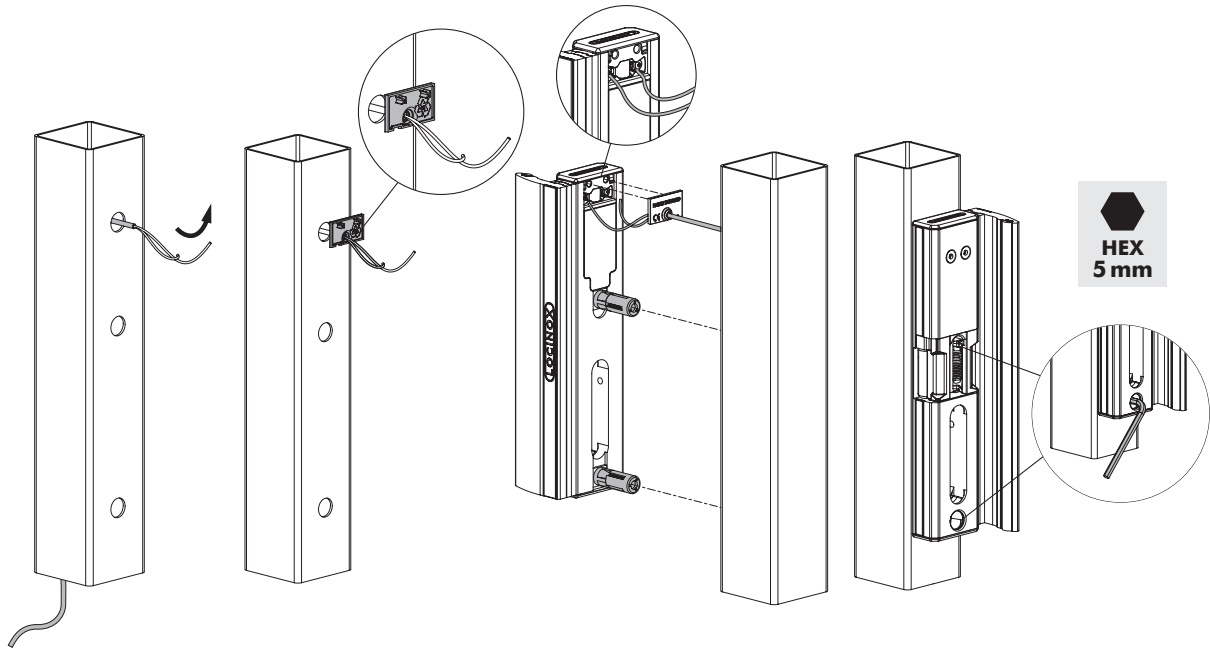

⑤ Connecting

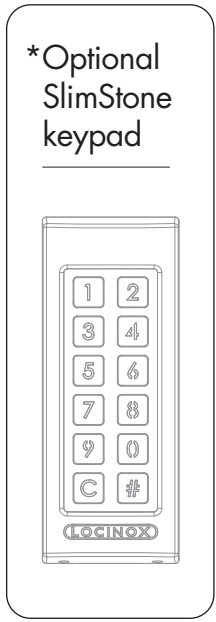
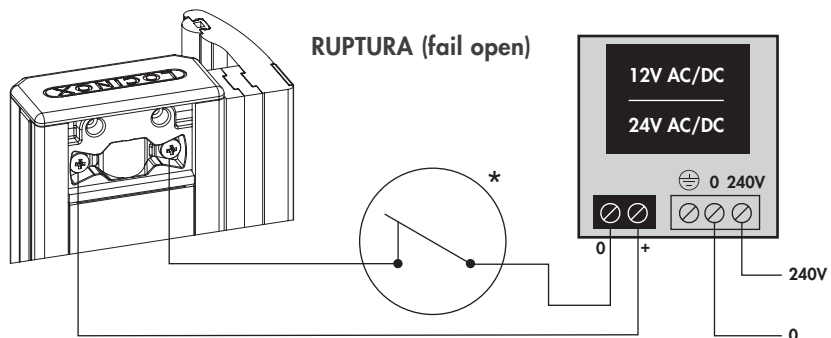
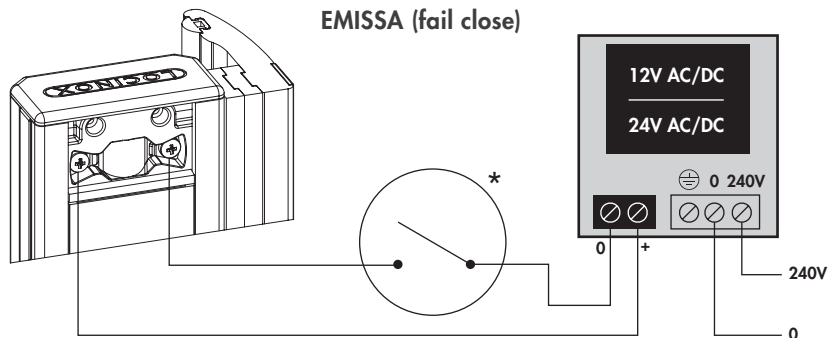

Technical specifications



U: 12 V AC/DC
 I: 1,25 A
 U: 24 V AC/DC
 I: 0,62 A
 P: 15 W